

INSIDE L800V2

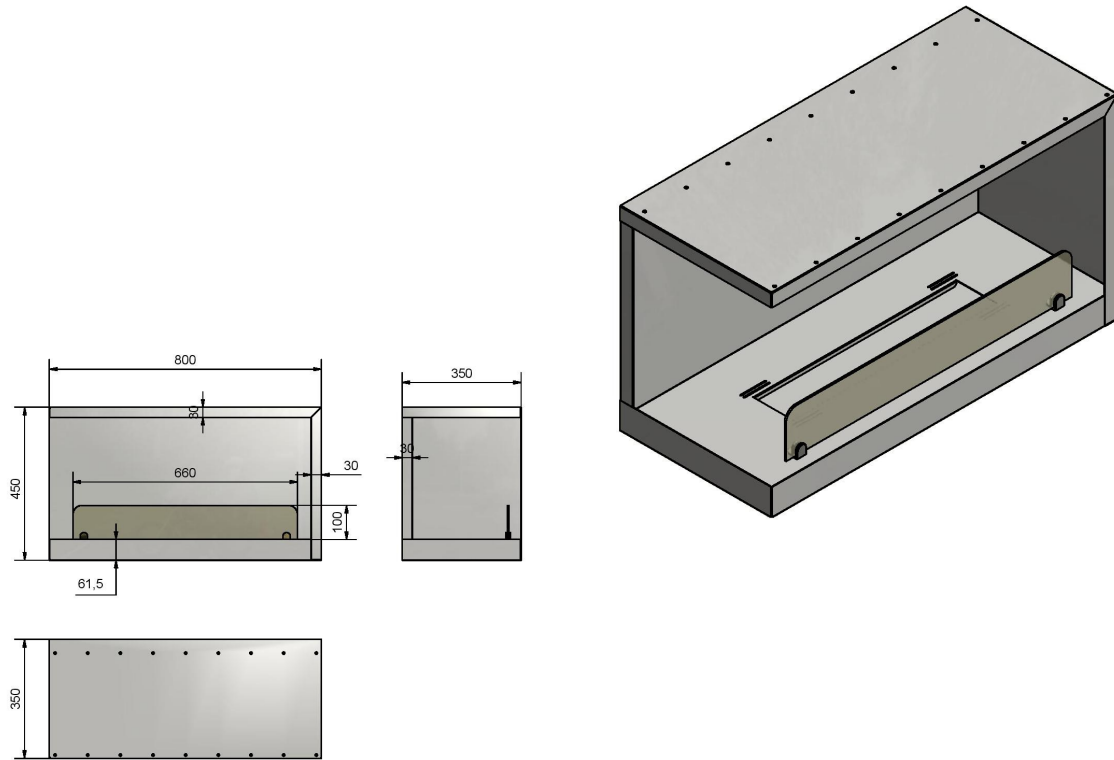

1. Technical description:

Color: Black
Size: 800X450X350mm
Weight: 20kg

2. Components and kit:

Burner: 500mm, capacity 1,0 liter 4mm stainless steel INOX
Glass: 4mm tempered glass – tinted

3. Material:

Powder coated steel