



GLOW FIRE

MOZART



MADE IN GERMANY

Deutsch: Reinigung und Pflege durch Abwischen mit einem feuchten Tuch und nachwischen mit einem trockenen Tuch. Bitte entfernen Sie während des Aufbauvorgangs die Etiketten der Montagebeschriftung.

English: Cleaning and care by wiping with a damp cloth and wiping with a dry cloth. Please remove the labels of the assembly inscription during the assembly process.

Français: Nettoyage et entretien en essuyant avec un chiffon humide et en essuyant avec un chiffon sec. Veuillez retirer les étiquettes de l'inscription de l'assemblage pendant le processus d'assemblage.

Dansk: Rengøring og pleje ved at tørre af med en fugtig klud og tørre af med en tør klud. Fjern etiketterne på samlingsindskriften under samleprocessen.

Español: Limpieza y cuidado pasando un paño húmedo y pasando un paño seco. Retire las etiquetas de la inscripción del ensamblaje durante el proceso de ensamblaje.

Italiano: Pulizia e cura strofinando con un panno umido e strofinando con un panno asciutto. Si prega di rimuovere le etichette della scritta di assemblaggio durante il processo di assemblaggio.

Polski: Czyszczenie i pielęgnacja poprzez przecieranie wilgotną szmatką i wycieranie suchą szmatką. Proszę usunąć etykiety z napisem montażowym podczas procesu montażu.

Eesti: Puhastamine ja hooldamine pühkides niiske lapiga ja pühkides kuiva lapiga. Palun eemaldage montaaži protsessi käigus montaaži pealdise sildid.

Portugues: Limpeza e cuidado passando um pano úmido e enxugando com um pano seco. Por favor, remova as etiquetas da inscrição de montagem durante o processo de montagem.

Русский: Чистка и уход путем протирания влажной тканью и вытирания сухой тканью. Пожалуйста, удалите этикетки с надписью сборки в процессе сборки.

Венгерский: Чистка и уход путем протирания влажной тканью и вытирания сухой тканью. Kérjük, távolítsa el az összeszerelési felirat címkeit az összeszerelési folyamat során.

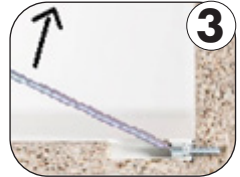
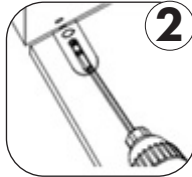
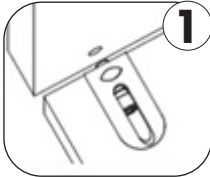
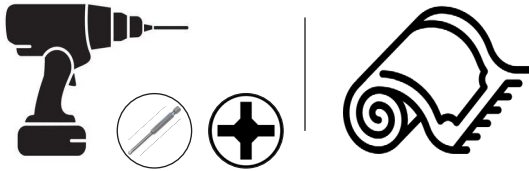
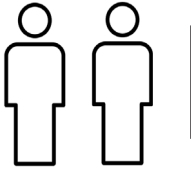



Length: 552.00
Width: 100.00

Schwarze Platten
Montage **18**

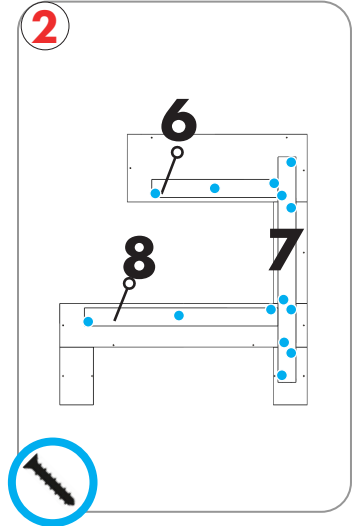
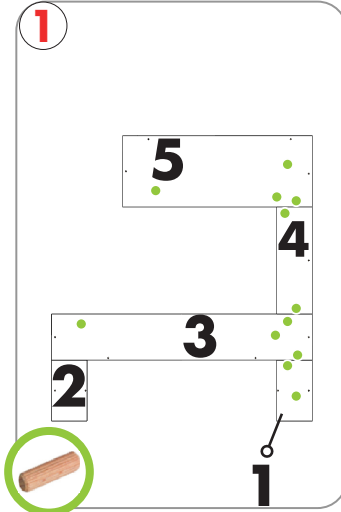
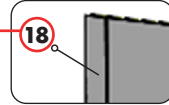



030 837 98 860

info@glow-fire.com

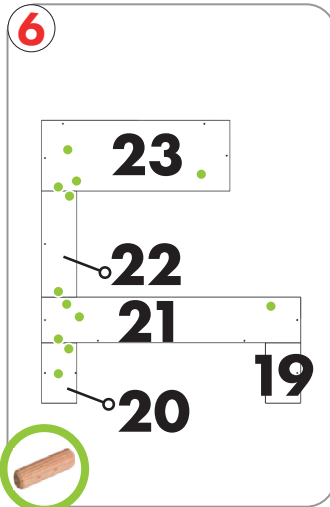
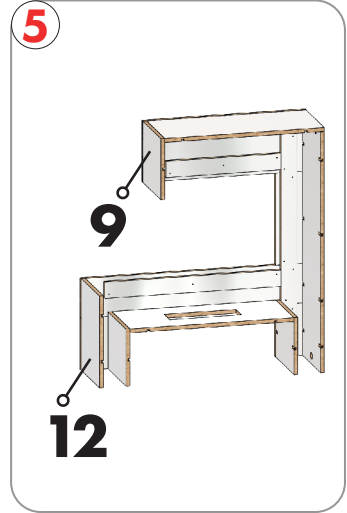
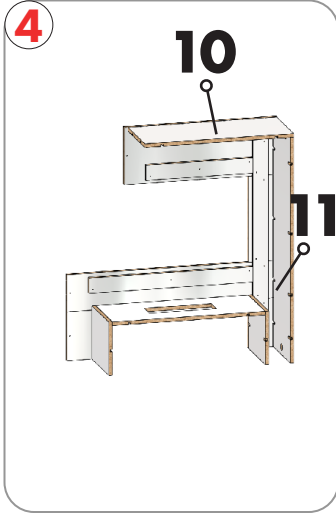



Length: 552.00
Width: 100.00

Schwarze Platten
Montage **18**

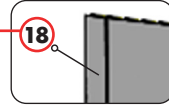

7

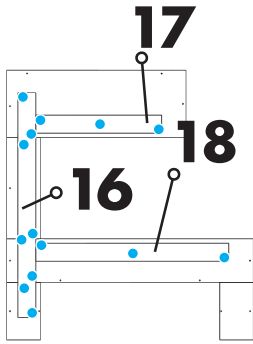

8

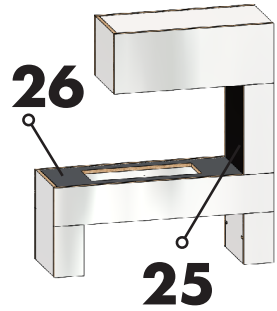

9

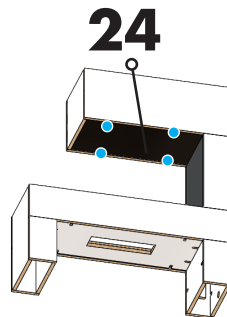



030 837 98 860

✉ info@glow-fire.com

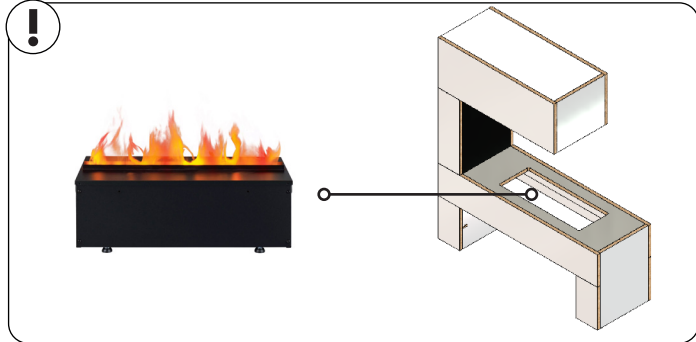
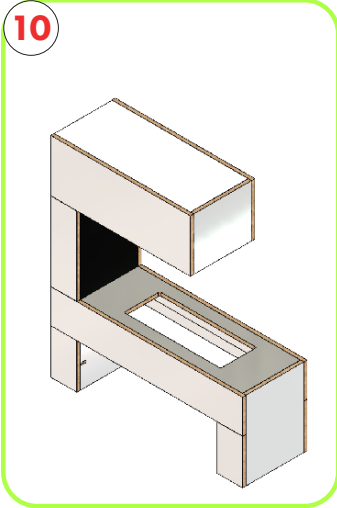

Für die Nachbestellung benötigen wir die abgebildete Nummer auf dem Brett
For reordering we need the number shown on the board

GLOW FIRE		0002536
Length: 552.00	Schwarze Platten	
Width: 100.00	Montage - 18	
		



Glow Fire GmbH
Lilienthalstraße 10, 15344 Strausberg,
E-Mail: info@glow-fire.com
Telefon: 030 837 98860
Eingetragen beim Amtsgericht Frankfurt (Oder), HRB 20198 FF
WEEE-Nr. DE 67732298