



GLOW FIRE

**KLEIST**

OMC 500 | 600



---

**MADE IN GERMANY**

**Deutsch:** Reinigung und Pflege durch Abwischen mit einem feuchten Tuch und nachwischen mit einem trockenen Tuch. Bitte entfernen Sie während des Aufbauvorgangs die Etiketten der Montagebeschriftung.

**English:** Cleaning and care by wiping with a damp cloth and wiping with a dry cloth. Please remove the labels of the assembly inscription during the assembly process.

**Français:** Nettoyage et entretien en essuyant avec un chiffon humide et en essuyant avec un chiffon sec. Veuillez retirer les étiquettes de l'inscription de l'assemblage pendant le processus d'assemblage.

**Dansk:** Rengøring og pleje ved at tørre af med en fugtig klud og tørre af med en tør klud. Fjern etiketterne på samlingsindskriften under samleprocessen.

**Español:** Limpieza y cuidado pasando un paño húmedo y pasando un paño seco. Retire las etiquetas de la inscripción del ensamblaje durante el proceso de ensamblaje.

**Italiano:** Pulizia e cura strofinando con un panno umido e strofinando con un panno asciutto. Si prega di rimuovere le etichette della scritta di assemblaggio durante il processo di assemblaggio.

**Polski:** Czyszczenie i pielęgnacja poprzez przecieranie wilgotną szmatką i wycieranie suchą szmatką. Proszę usunąć etykiety z napisem montażowym podczas procesu montażu.

**Eesti:** Puhastamine ja hooldamine pühkides niiske lapiga ja pühkides kuiva lapiga. Palun eemaldage montaaži protsessi käigus montaaži pealdise sildid.

**Portugues:** Limpeza e cuidado passando um pano úmido e enxugando com um pano seco. Por favor, remova as etiquetas da inscrição de montagem durante o processo de montagem.

**Русский:** Чистка и уход путем протирания влажной тканью и вытирания сухой тканью. Пожалуйста, удалите этикетки с надписью сборки в процессе сборки.

**Венгерский:** Чистка и уход путем протирания влажной тканью и вытирания сухой тканью. Kérjük, távolítsa el az összeszerelési felirat címkéit az összeszerelési folyamat során.

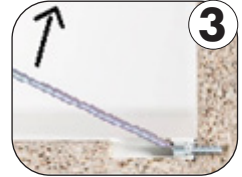
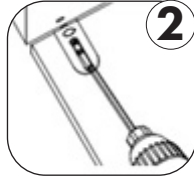
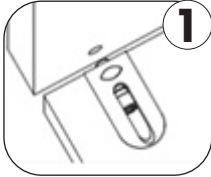
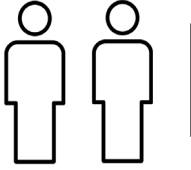



Length: 552.00  
Width: 100.00

Schwarze Platten  
Montage **18**

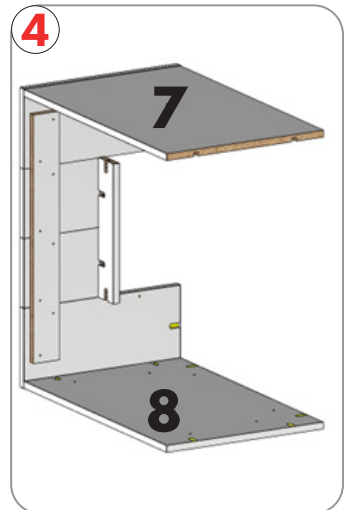
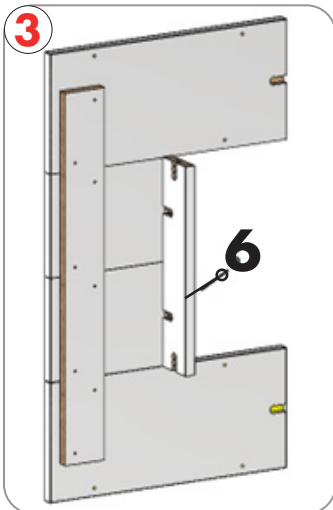
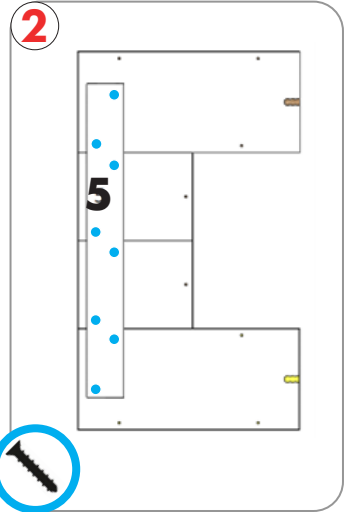
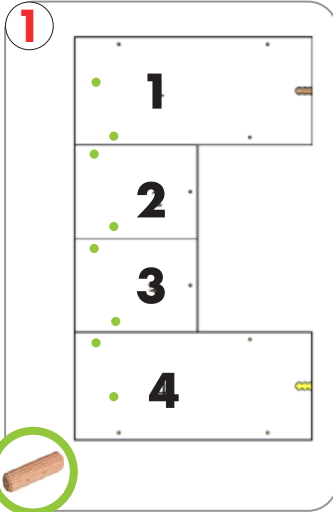
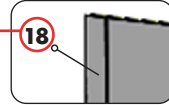



030 837 98 860

info@glow-fire.com

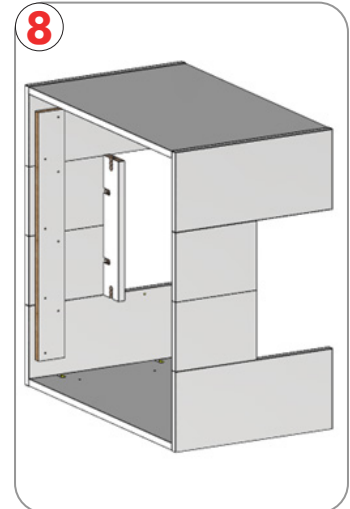
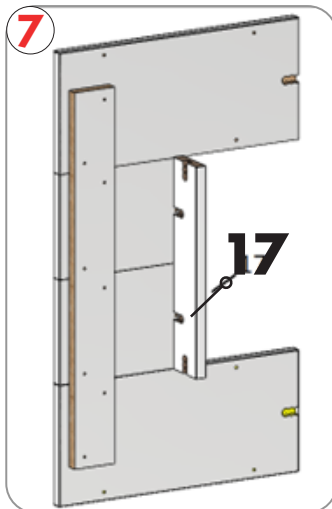
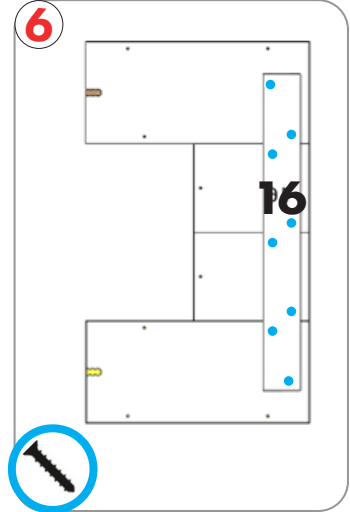
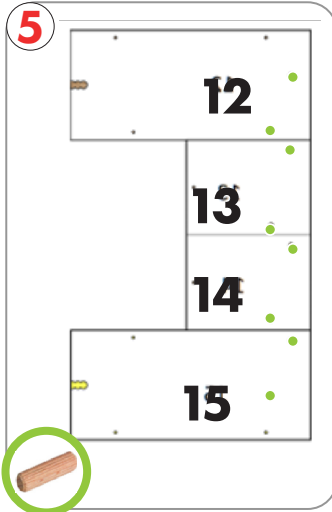



Length: 552.00  
Width: 100.00

Schwarze Platten  
Montage **18**

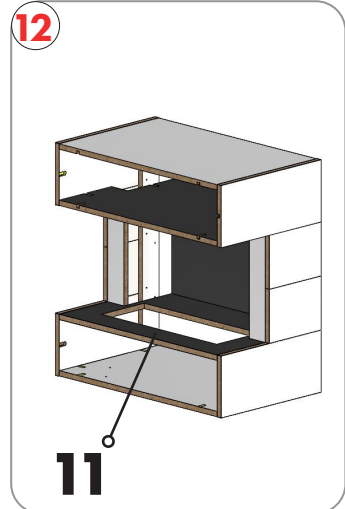
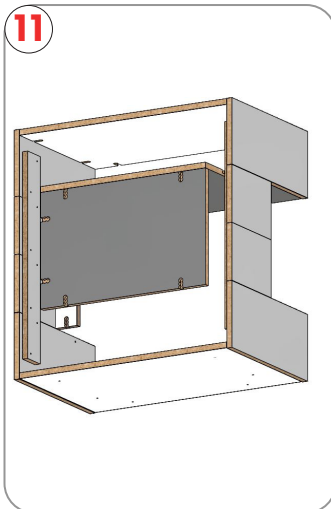
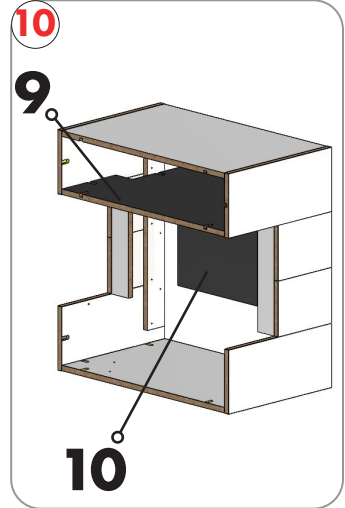
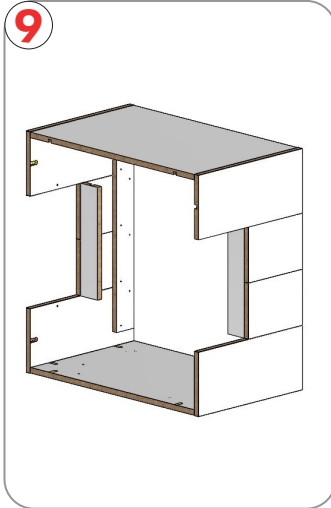
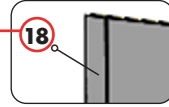



030 837 98 860

info@glow-fire.com

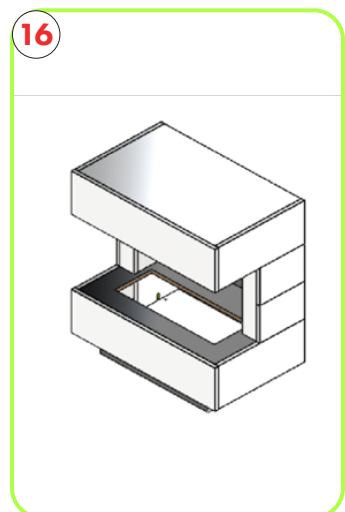
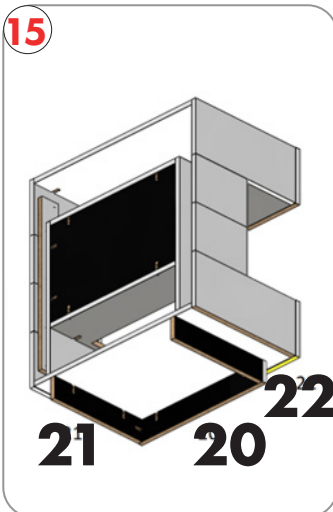
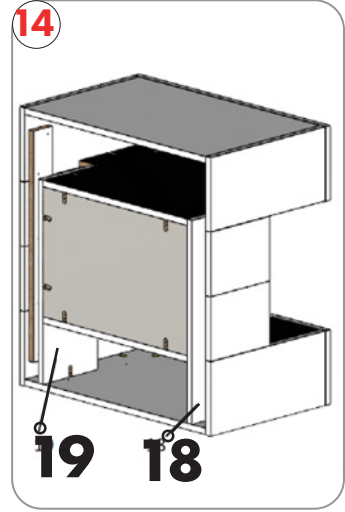
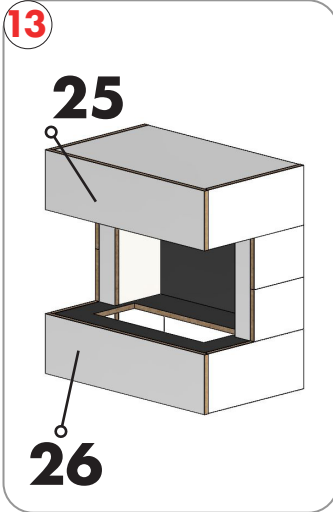

---

Für die Nachbestellung benötigen wir die abgebildete Nummer auf dem Brett  
For reordering we need the number shown on the board

GLOW FIRE	0002536
Length: 552.00 Width: 100.00	Schwarze Platten Montage - 18
	



Glow Fire GmbH  
Lilienthalstraße 10, 15344 Strausberg,  
E-Mail: [info@glow-fire.com](mailto:info@glow-fire.com)  
Telefon: 030 837 98860  
Eingetragen beim Amtsgericht Frankfurt (Oder), HRB 20198 FF  
WEEE-Nr. DE 67732298