



GLOW FIRE

SCHILLER WALL

OMC 500 | 600



MADE IN GERMANY

Deutsch: Reinigung und Pflege durch Abwischen mit einem feuchten Tuch und nachwischen mit einem trockenen Tuch.

Um das Umkippen des Möbelstückes zu verhindern, befestigen Sie es bitte mit geeignetem Befestigungsmaterial (nicht im Lieferumfang enthalten) an der Wand. Beachten Sie dabei die Wandbeschaffenheit (Beton/Trockenbau). Bitte entfernen Sie während des Aufbaus die Etiketten der Montagebeschriftung.

English: Cleaning and care by wiping with a damp cloth and wiping with a dry cloth. To prevent the piece of furniture from tipping over, please fasten it to the wall with suitable fastening material (not included in the scope of delivery). Please note the condition of the wall (concrete/drywall). Please remove the labels of the assembly inscription during the assembly process.

Français: Nettoyage et entretien en essuyant avec un chiffon humide et en essuyant avec un chiffon sec. Pour éviter que le meuble ne bascule, veuillez le fixer au mur avec un matériel de fixation approprié (non compris dans la livraison). Veuillez noter l'état du mur (béton/cloison sèche). Veuillez retirer les étiquettes de l'inscription de l'assemblage pendant le processus d'assemblage.

Dansk: Rengøring og pleje ved at tørre af med en fugtig klud og tørre af med en tør klud. For at forhindre, at møblet vælter, skal det fastgøres til væggen med passende fastgørelsesmateriale (medfølger ikke i leveringsomfanget). Bemærk venligst væggens tilstand (beton/gipsvæg). Fjern etiketterne på samlingsindskriften under samleprocessen.

Espanol: Limpieza y cuidado pasando un paño húmedo y pasando un paño seco. Para evitar que el mueble vuelque, fíjelo a la pared con un material de fijación adecuado (no incluido en el volumen de suministro). Tenga en cuenta el estado de la pared (hormigón/paneles de yeso). Retire las etiquetas de la inscripción del ensamblaje durante el proceso de ensamblaje.

Italiano: Pulizia e cura strofinando con un panno umido e strofinando con un panno asciutto. Per evitare che il mobile si ribalti, si prega di fissarlo alla parete con materiale di fissaggio adatto (non incluso nella fornitura). Si prega di notare le condizioni del muro (cemento/cartongesso). Si prega di rimuovere le etichette della scritta di assemblaggio durante il processo di assemblaggio.

Polski: Czyszczenie i pielęgnacja poprzez przecieranie wilgotną szmatką i wycieranie suchą szmatką. Aby zapobiec przewróceniu się mebla, należy przymocować go do ściany za pomocą odpowiedniego materiału mocującego (nie wchodzi w zakres dostawy). Proszę zwrócić uwagę na stan ściany (beton/gips). Proszę usunąć etykiety z napisem montażowym podczas procesu montażu.

Eesti: Puhastamine ja hooldamine pühkides niiske lapiga ja pühkides kuiva lapiga. Mööbli ümbermineku vältimiseks kinnitage see sobiva kinnitusmaterjaliga (ei kuulu tarnekomplekti) seina külge. Pange tähele seina seisukorda (betoon/kipsplaat). Palun eemaldage montaažiprotsessi käigus montaaži pealdise sildid.

Portugues: Limpeza e cuidado passando um pano úmido e enxugando com um pano seco. Para evitar que o móvel tombe, fixe-o à parede com material de fixação adequado (não incluído no volume de fornecimento). Por favor, observe a condição da parede (concreto/drywall). Por favor, remova as etiquetas da inscrição de montagem durante o processo de montagem.

Русский: Чистка и уход путем протирания влажной тканью и вытирания сухой тканью. Чтобы предмет мебели не опрокинулся, закрепите его на стене с помощью подходящего крепежного материала (не входит в комплект поставки). Обратите внимание на состояние стены (бетон/гипсокартон). Пожалуйста, удалите этикетки с надписью сборки в процессе сборки.

Венгерский: Чистка и уход путем протирания влажной тканью и вытирания сухой тканью. A bútordarab felborulásának elkerülése érdekében kérjük, rögzítse a falhoz megfelelő rögzítőanyaggal (nem része a szállítási terjedelemnek). Kérjük, vegye figyelembe a fal állapotát (beton/gipszkarton). Kérjük, távolítsa el az összeszerelési felirat címkéit az összeszerelési folyamat során.

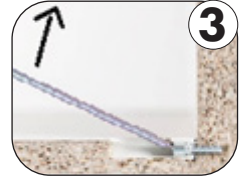
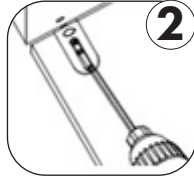
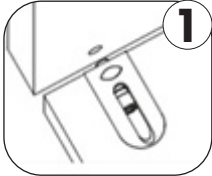
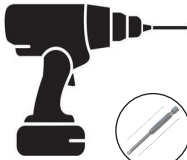



Length: 552.00
Width: 100.00

Schwarze Platten
Montage 18

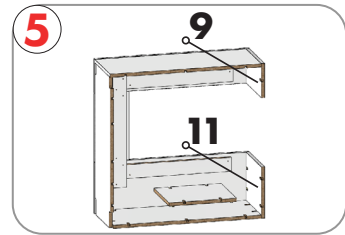
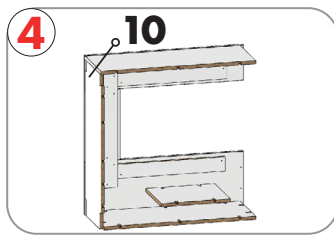
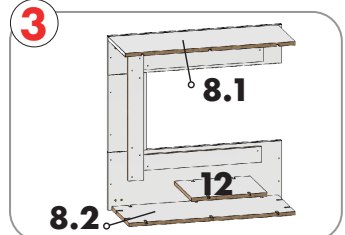
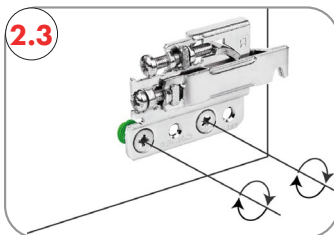
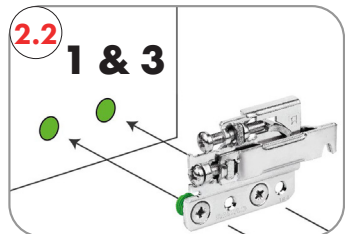
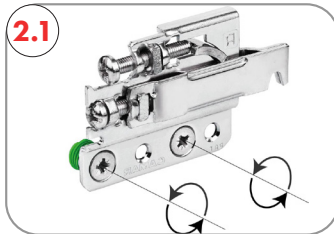
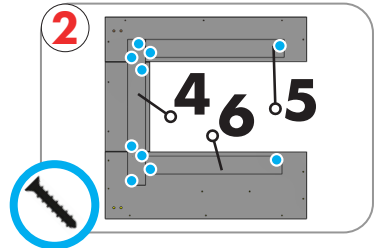
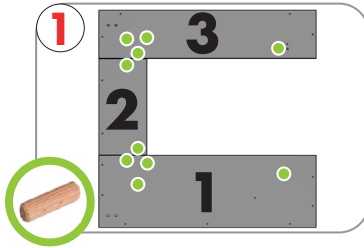
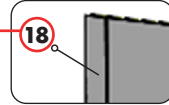



☎ 030 837 98 860

✉ info@glow-fire.com

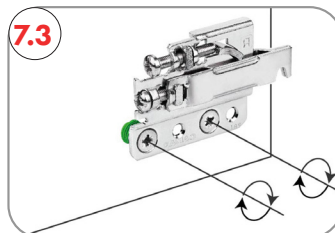
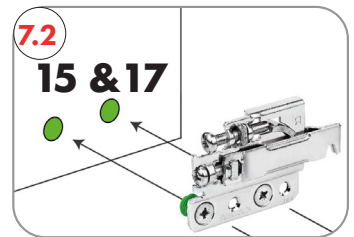
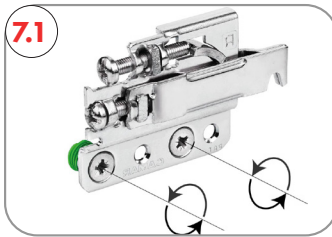
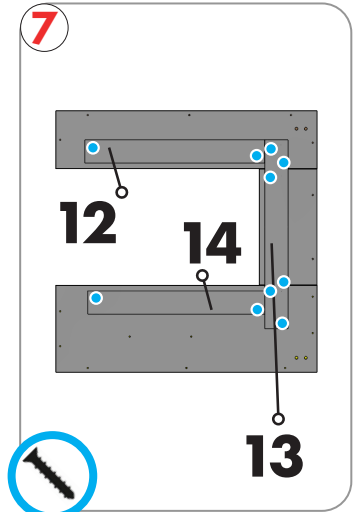
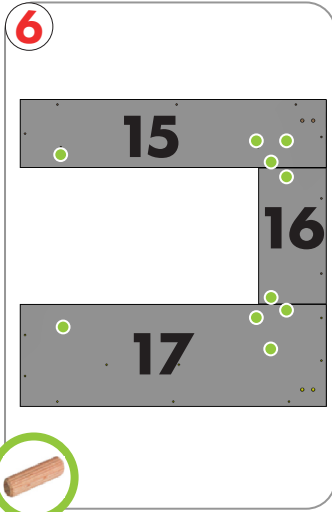



Length: 552.00
Width: 100.00

Schwarze Platten
Montage **18**

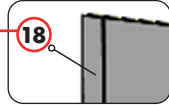

8

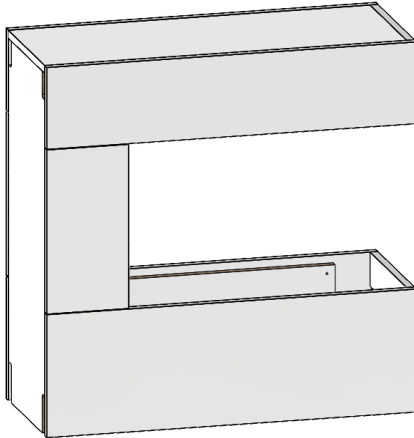

9

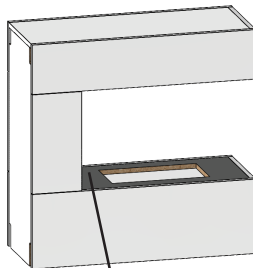

20



030 837 98 860

info@glow-fire.com

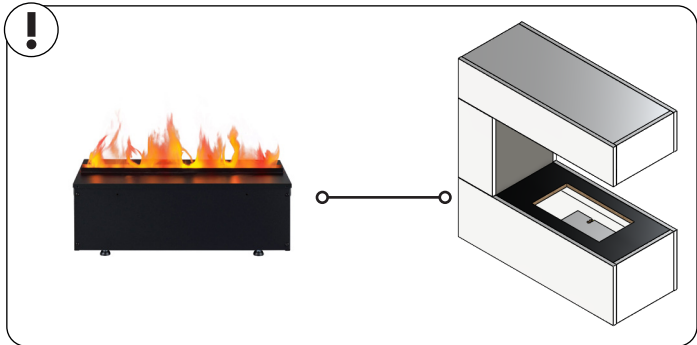
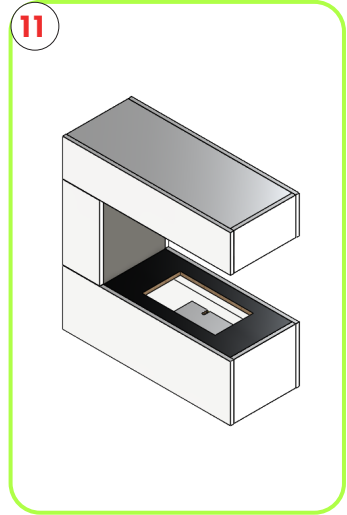
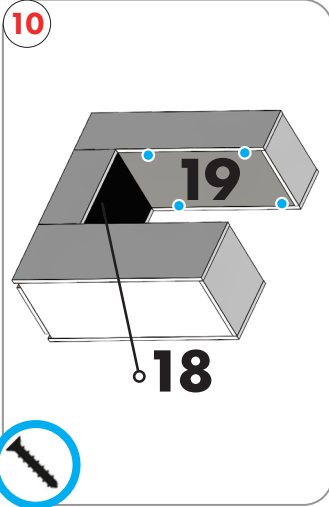

Für die Nachbestellung benötigen wir die abgebildete Nummer auf dem Brett
For reordering we need the number shown on the board

GLOW FIRE	0002536
Length: 552.00 Width: 100.00	Schwarze Platten Montage - 18
	



Glow Fire GmbH
Lilienthalstraße 10, 15344 Strausberg,
E-Mail: info@glow-fire.com
Telefon: 030 837 98860
Eingetragen beim Amtsgericht Frankfurt (Oder), HRB 20198 FF
WEEE-Nr. DE 67732298